

25 YEARS
OF EXPERIENCE

[PORTA]
DOORS

STEEL DOORS EXTERIOR AND TECHNICAL

TOP QUALITY DOORS

FROM PROFESSIONALS FOR PROFESSIONALS





The Headquarters of
the Group
PORTA KMI POLAND,
Bolszewo,
ul Szkolna 54

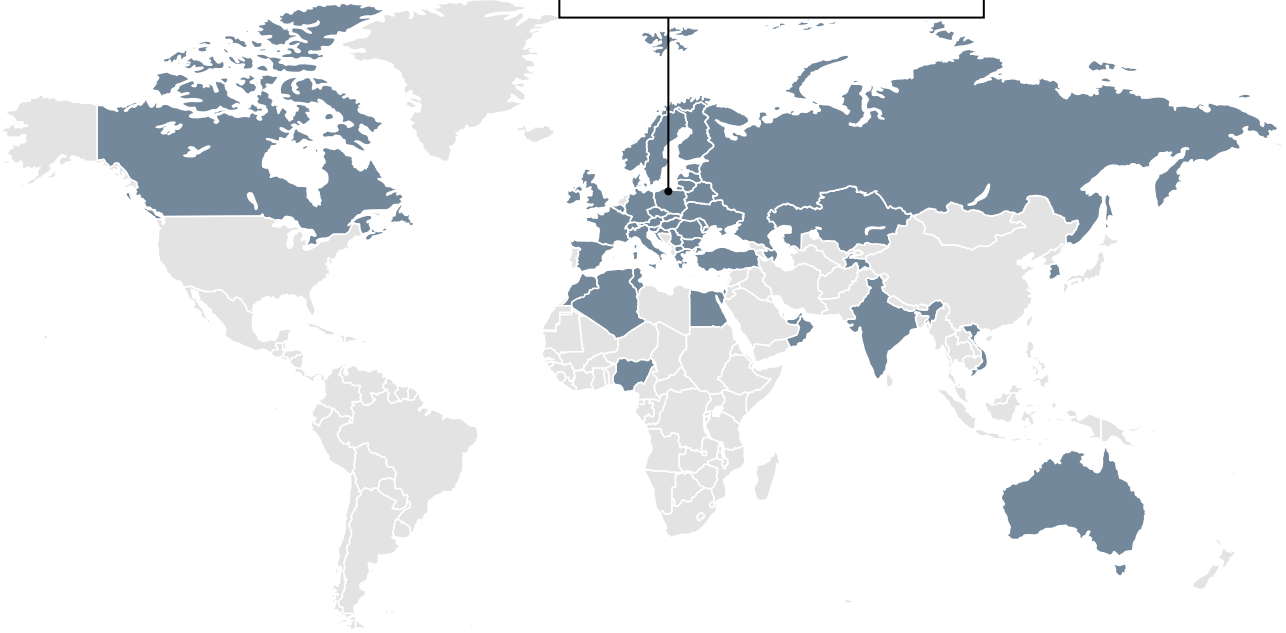

Over 25 years of experience in door production

PORTA KMI POLAND is one of the best known and most innovative door manufacturers in Poland and abroad. For over 25 years we have produced more than 12 million door leaves and door frames.

Currently we dispose several locations of production facilities - four plants in Poland, including the most recent built in year 2016, Porta Steel Factory, and one in Romania. This allows us to offer our customers a comprehensive solution in the field of wooden and metal doors. Each month, tens of thousands of new Porta doors are sold in Poland and Europe. Our doors have been installed in many prestigious buildings designed by leading architects and designers.

Every step of the doors production process is supervised by qualified professionals, who contribute to maintain a high quality of products. The specialists of Innovation and R&D Departments continually review trends in international design, adapting them to customers' needs.

Porta factories is 105 tys. m² of production and storage space. Porta Factory is also the synonym of modern production facilities equipped with the latest generation of machines dedicated to door leaves and door frames production, supplied by leading european manufacturers. Raw materials and other resources used in the door production process are selected with extreme precision and attention to quality. All that is being done so that our doors may decorate your home over the years.

TABLE OF CONTENTS

4	PORTA STEEL Factory
6	Advantages of steel doors
8	Application of internal doors
10	Application of internal doors
12	Steel doors – application scopes
14	Steel ENTRANCE DOORS
16	Basic information about steel entrance doors
18	Steel SAFE RC2
20	Steel SAFE RC2 with Thermo
22	Steel SAFE RC3
24	Steel SAFE RC3 with Thermo
26	Steel ENERGY PROTECT
28	Steel ARCTIC PASSIVE
30	Steel INTERNAL doors
32	Basic information about steel internal doors
34	UNIVERSAL DOORS TO STOREROOMS
36	Metal BASIC
38	Metal SOLID
40	Metal EI30, EI60
42	Transoms
44	Thresholds
46	Panels
48	Accessories
50	Tables of dimensions
52	Complex offer of PORTA DOORS
54	Adapt doors to fit your needs

PORTA STEEL Factory



MODERN MACHINE PARK

The fully automated varnishing room and 1.5 km of hanger transport system, are only some of examples of newest Porta factory. The most modern machine park from leading European manufacturers is one of the key elements guaranteeing rarely encountered efficiency, flexibility and precision.



COMPREHENSIVE CONSULTING

An experienced team of high qualified technical advisors ensures that the client receive a product with expected parameters in compliance with standards of the building regulations. A special, dedicated offer, which meets the expectations laid down by the building main architect, is developed for investment clients.

THE NEWEST AND MOST MODERN PORTA FACTORY

In year 2016 Porta company has relocated the production of steel door leaves and door frames into one of the most modern facilities in Europe which places the company among the very few companies having such a comprehensive offer. The new facility is located next to the already existing factory in Elk City and occupies a total area of approx. 14.5 thousand m². The investment worth more than 70 million PLN allows to achieve not listed previously efficiency of producing one door frame per minute. The modern system of hanger transport with a length of 1.5 km reinforces 75 modern specialised machines and represent only some of Porta Steel prominent symbols.



THE QUALITY AT THE TOP LEVEL

Implemented many years ago and still maintained Quality Assurance ISO 9001 system, witnessed by proper certificate is a guarantee of repeatability of PORTA products high quality, which is further confirmed by certificates of conformity issued by Building Research Institute.



BEST DESIGN ADAPTED TO THE NEEDS

The team of designers and constructors tracking current global trends, continually updates the Porta offer in this aspect. At the same time a strong emphasis is put on adapting to individual architects' needs and uniqueness of designs and technical solutions.

The factory is environmentally friendly. Intelligent planning allows to fully control the waste. The unique, automated door frame production line, modern varnishing room and the whole machine park from leading european producers make Porta Steel one of the most modern factories in Europe. In addition to the door frame production, the establishment also offers a wide range of steel doors, both internal and external.



WHY PORTA DOORS

- ADAPTING TO THE NEEDS
- WIDE OFFER
- STYLISTICS/DESIGN
- QUALITY OF PERFORMANCE
- MODERN MACHINE PARK
- FAST AND EASY ASSEMBLY
- KNOWLEDGE
- QUALITY OF SERVICE
- OPERATING PERSONNEL
- CERTIFICATES AND APPROVALS

ADVANTAGES OF METAL DOORS

Steel doors are widely used in houses, apartments and in places where door operating conditions require a higher resistance to loads, mechanical damages and corrosion. The use of metal materials does not preclude the creation of interesting and structurally advanced products. Well integrated doors may constitute an architectural detail that bonds the whole interior. The precision of performance combined with a high-quality powder coating in any color, enables manufacturing of a product adapted to individual needs.



DURABILITY

- high durability confirmed with longterm warranty
- exploitation costs reduced to minimum
- high level of humidity resistance
- high quality of finishing coats
- possibility of use as internal and external doors



QUALITY

- perfect performance of each solution



DESIGN

- implementation in accordance with norms of selected country
- possibility of manufacturing in accordance with architectural project
- possibility of adaptation to users needs
- possibility of application of various coats
- efficient and quick assembly
- accessories raising functionality of doors

APPLICATION OF INTERNAL DOORS

UNIVERSAL DOORS TO UTILITY ROOMS

- storerooms
- utility rooms
- backrooms
- backrooms
- industrial premises



Metal BASIC

- utility rooms
- industrial premises
- office premises
- gastronomic premises
- backrooms, cellars, garages
- recreational halls
- toilet rooms



Metal SOLID

- intended for use in heavy-duty conditions
- utility rooms
- industrial premises
- backrooms, cellars
- workshops, garages, production shop floors
- modern living and office interiors (loft design)



Metal EI30, EI60

- 30- and 60-minute fireproof
- heavy duty conditions
- internal or entrance
- TYPE 1 EI 60 – smokeproof with acoustic level at 37 dB
- hotels, boarding houses
- doors to boiler rooms, doors to garages
- public utility buildings



EXAMPLES OF INTERNAL METAL DOORS USE



SHOPPING MALL
Metal SOLID



RESIDENTIAL ESTATE
UNIVERSAL DOORS TO UTILITY
ROOMS



CENTRE OF FINE ARTS
Metal SOLID



RESIDENTIAL ESTATE
UNIVERSAL DOORS TO UTILITY
ROOMS



GARAGE HALL
Metal EI30,EI60



CENTRE OF FINE ARTS
Metal SOLID



CENTRE OF FINE ARTS
Metal SOLID



COLLEGE
Metal SOLID



GARAGE HALL
Metal EI30,EI60

SHEET METAL TYPES IN STEEL INTERNAL DOORS

- **STEEL SHEET METAL**
OF DX51D, DX52D, DX53D CLASS
hot galvanised
(zinc volume: 100-275 g/m² acc. to EN 10346)
- **STEEL SHEET METAL**
OF DX51D, DX52D, DX53D CLASS
hot galvanised
(zinc volume: 100-275 g/m² acc. to EN 10346),
surface finish with protective,
organic, painted coating
- **STEEL SHEET METAL**
OF DX51D, DX52D, DX53D CLASS
hot galvanised
(zinc volume: 100-275 g/m² acc. to EN 10346),
coated with decorative
wood-like or dyed PVC film
for internal applications
- **STEEL SHEET METAL**
OF DC01 CLASS, ELECTROLYTICALLY GALVANISED
(zinc volume: 18 g/cm² acc. to EN 10152)
- **STEEL SHEET METAL**
OF DC01 CLASS, ELECTROLYTICALLY GALVANISED
(zinc volume: 18 g/cm² acc. to EN 10152),
with painted,
organic, protective coating
- **STAINLESS STEEL SHEET**
OF 1.4301/1.4307 (V2A)
OR 1.4404 (V4A) CLASS ACC. TO EN 10088
- **COATED STEEL SHEET METAL**
OF DX51D, DX52D, DX53D CLASS
hot galvanised
(zinc volume: 225-275 g/m² acc. to EN 10346),
organic, polyester
resin-based coating





SELECTED COLORS OF RAL AND NCS PALLETE

Powder painted doors can be finished in the available RAL or NCS color and in different type of gloss (gloss, semi-gloss, matt) with increased resistance to abrasion, antibacterial, antigraffiti or antique forming the protection against corrosion.



STANDARD COLORS INCLUDED IN OFFER

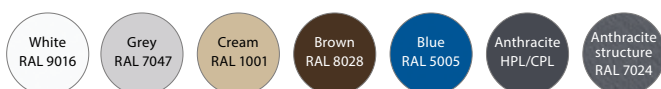

FINISH OF SURFACE



PROPERTIES AND FEATURES OF DIFFERENT FINISH TYPES

COMPARISON OF PROPERTIES AND FEATURES OF STEEL INDUSTRIAL DOOR FINISH TYPES

Finish types	Galvanised sheet metal	Coated sheet metal	Polyester paint	PVC-laminated sheet metal	Stainless steel
Characteristics	Steel with galvanised anticorrosive protection	Galvanised sheet metal with additional polyester resin-based organic film	After paint application, the coated components are heated to melt powder paint, resulting in uniform polymer film on the surface	Sheet metal and decorative foils can imitate natural wood or modern textures	Remarkable resistance to corrosion, acids and high temperatures
PORTA classification	★★★★☆☆	★★★★☆☆	★★★★☆☆	★★★★☆☆	★★★★★★
Steel industrial doors from the PORTA Offer	<ul style="list-style-type: none"> • UNIVERSAL DOORS TO UTILITY PREMISES • Metal BASIC • Metal SOLID 	<ul style="list-style-type: none"> • Metal BASIC 	<ul style="list-style-type: none"> • UNIVERSAL DOORS TO UTILITY PREMISES • Metal SOLID • Metal EI 30 / EI 60 	<ul style="list-style-type: none"> • Metal SOLID 	<ul style="list-style-type: none"> • Metal SOLID
Application	Utility rooms at residential buildings	Utility rooms at residential buildings	Residential buildings, hotels, public utility buildings	Hotels and public utility buildings	Specific-purpose utility premises

APPLICATION OF PORTA DOORS

Thanks to our 25 years of experience, PORTA steel doors are applied in the highest standard buildings. It will fit in often frequented residential spaces and in less frequented but exposed to greater fluctuations in temperature, humidity or to repeated mechanical damages of its surface.

THE PUBLIC BUILDINGS

Apart from the representative design of interiors of such buildings as airports, railway stations, shopping malls, doors should be made of durable materials. The use of steel doors is an essential solution to this type of buildings. Thanks to a wide range of Porta manufacturing possibilities, a set of door with a door frame may create an impression of lightness in a solid product. A steel Porta doors guarantees a perennial reliability in public buildings.



HOSPITALS, CLINICS, PHARMACEUTICAL COMPANIES, LABORATORIES, NURSING HOMES

It is essential that the joinery presents proper parameters in buildings where high hygiene standards are a priority for correct functioning. Steel doors will be an optimal choice, if we wish to keep cleanness in patient rooms, examination rooms, operating rooms and in all rooms with increased humidity level.



INDUSTRIAL PLANTS, GARAGES, UTILITY ROOMS

In this type of interiors, steel doors are the best possible solution. A complete set of doors shall meet fire insulation conditions as the mentioned locations are often used to store flammable materials. The steel, used in doors production process proves a resistance to deformations and environmental factor's influence.



RESIDENTIAL BUILDINGS

A practical and more often selected solution for houses and apartments is solid steel doors. It guarantees not only the safety, but also the durability for years. Modern steel doors are used in new and older buildings which need to be renovated.



HOTELS, GUEST HOUSES

Buildings where crowds of people appear every day, dragging their luggage and hitting walls with it, require high resistance parameters' solutions. Furthermore, door sets shall fit in the interior design and architecture of hotels and guest houses. Solid Porta doors are very easy to maintain, therefore they are perfect for rooms, passages between rooms and other often frequented rooms.



SCHOOLS, KINDERGARTENS, OFFICE BUILDINGS

Thanks to high standards in mechanical resistance and safety of Porta steel doors, they shall meet the requirements of such areas as offices, schools and kindergartens. It is indispensable to adjust the shape of profiles to use conditions in those areas to minimize the risk of accident and to ensure the safety of office workers, children and their guardians. In such places, steel doors with top and side transoms are often used.



STEEL ENTRANCE DOORS





EXTERIOR

BASIC INFORMATIONS ABOUT EXTERIOR DOORS

PRODUCT OF
PORTA STEEL

ENGINEERING STRUCTURE

Steel SAFE RC2, Steel SAFE RC3, Steel SAFE RC2 THERMO, Steel SAFE RC3 THERMO

- Double-layer wooden beams in door leaf
- Steel SAFE RC3 models are additionally strengthened with a steel angle bar
 - 100 mm steel external, angular frame; an additional thermal plate and a thermal threshold
- Steel ENERGY PROTECT
- Double-layer wooden beams in door leaf, strengthened with a steel angle bar
 - 100 mm steel external, angular frame with an additional thermal plate and a thermal threshold
- Steel ARCTIC PASSIVE
- Wooden frame-panel • Door frame - multilayer glued coniferous timber
 - Wooden door frame with 1.5 mm galvanised steel cladding

CORE



MINERAL WOOL
available at extra charge

Steel SAFE RC2, Steel SAFE RC3, Steel SAFE RC2 THERMO, Steel SAFE RC3 THERMO, Steel ENERGY PROTECT



EXPANDED POLYSTYRENE WITH
BIG GRAPHITE ADDITION
all collections

GLAZING

- Reflex type glass pane, combined glazing with 0.5 coefficient and P4 anti-burglery class
- Stainless-steel frames (frame for inox pane)

SEALING

Steel SAFE RC2, Steel SAFE RC2 THERMO, Steel SAFE RC3, Steel SAFE RC3 THERMO, Steel ENERGY PROTECT

- Double door sealing at the interface of door frame with door leaf
- Sealing system on the entire door circumference

Steel ARCTIC PASSIVE

Door leaf tightness is guaranteed by a double system of seals, the first and the second system, incorporated into door leaf and door frame, is seamless (uninterrupted) and protect the door from four sides

THRESHOLD

Steel SAFE RC2, Steel SAFE RC3 • Stainless-steel threshold with perforation
Steel SAFE RC2 THERMO, Steel SAFE RC3 THERMO, Steel ENERGY PROTECT • Thermal threshold with increased heat transfer coefficient (made of inox stainless steel)
Steel ARCTIC PASSIVE • ThermoControl threshold (wooden core with stainless steel cladding)



ACCESSORIES

- **Two independent LOB locks** Steel SAFE RC2, Steel SAFE RC2 THERMO
- **Winkhaus hook lock** Steel SAFE RC3, Steel SAFE RC3 THERMO, Steel ENERGY PROTECT, Steel ARCTIC PASSIVE
- **Additional upper lock** Steel SAFE RC3, Steel SAFE RC3 THERMO, Steel ENERGY PROTECT, Steel ARCTIC PASSIVE
- **The adjustment of the main lock striker in a door frame** Steel SAFE RC2, Steel SAFE RC2 THERMO, Steel SAFE RC3, Steel SAFE RC3 THERMO, Steel ENERGY PROTECT.
- **The adjustment of all locking points of the lock in a door frame** Steel ARCTIC PASSIVE
- **Three 3-element** Steel SAFE RC2, Steel SAFE RC2 THERMO, Steel SAFE RC3, Steel SAFE RC3 THERMO, Steel ENERGY PROTECT
- **Three 3D hinges** Steel ARCTIC PASSIVE
- **Four interlocking door bolts**
- **OPAL handle in safety class 2** Steel SAFE RC2, Steel SAFE RC2 THERMO
- **SAFE handle in safety class 3** Steel SAFE RC3, Steel SAFE RC3 THERMO, Steel ENERGY PROTECT, Steel ARCTIC PASSIVE
- **Assembly set • Cylinder locks**
- **Eyehole (in full door leaf)**
- **Drip tray in colour of door leaf, for door opening to the inside**
- **Stiff chain** Steel SAFE RC3, Steel SAFE RC3 Z THERMO, Steel ENERGY PROTECT, Steel ARCTIC PASSIVE
- **1500 mm round handle • 1500 mm rectangular handle**
- **Upper escutcheon**
- **Self-closer**
- **Lower 150 mm stainless steel panel (A0, B1, F1 pattern)**
- **Preparation to shortening, lower protection (after self-shortening of door leaf)** Steel SAFE RC2, Steel SAFE RC2 THERMO, Steel SAFE RC3, Steel SAFE RC3 THERMO, Steel ENERGY PROTECT

FINISH TYPES

- Polyester paint
- PVC-laminated, galvanised sheet metal

PARAMETERS

- For solid doors

HEAT PERMEABILITY*	ANTI-BURGLERY RESISTANCE				ACOUSTIC INSULATION	WATER-PROOFNESS		
Ud	Ud	Ud	Ud	RC 2	RC 3	30 dB	3B	4A /5B
1.4	1.2	1.1	0.95	RC 2	RC 3	30 dB	3B	4A /5B

	Ud 1.4	Ud 1.2	Ud 1.1	Ud 0.95	RC 2	RC 3	30 dB	3B	4A /5B
Steel SAFE RC2	●	○	○	○	●	○	●	●	○
Steel SAFE RC2 THERMO	○	●	○	○	●	○	●	●	○
Steel SAFE RC3	●	○	○	○	○	●	●	○	●
Steel SAFE RC3 THERMO	○	●	○	○	○	●	●	○	●
Steel ENERGY PROTECT	○	○	●	○	○	●	●	○	●
Steel ECO ARCTIC	○	○	○	●	○	●*	●*	○	●*

* ITB Preliminary results

HEAT PERMEABILITY* This parameter indicates the level of heat energy which will permeate through the door (including the door frame) during one hour – LESS/BETTER.

ANTI-BURGLERY RESISTANCE Door resistance to unauthorised opening, verified and qualified to class 2 or 3, acc. to PN-ENV 1627:2012.

ACOUSTIC INSULATION Defined by R_w and D coefficient of acoustic insulation, indicates the decibel level of outdoor noise which the door will be able to attenuate.

WATERPROOFNESS Entrance doors are tested by the following two methods: "A" - for doors totally exposed to the effects of outdoor factors - and "B"

- for doors partially protected (under a roof) against outdoor factors and classified with regards to obtained test pressure at which no water leaks occurred.

Steel SAFE RC2

RC2* entrance door in anti-burglery version, applied in buildings. Available in a broad range of sheet metal covering with wood grain laminate or polyester paint coating.



Ud 1.4 W/m²K
HEAT TRANSFER COEFFICIENT*



STEEL DOOR FRAME
Large angular 100, external, in door leaf colour, with a seal



UPPER LOCK
upper, 3-rod control with a cylinder (one-key system)



PRIMARY LOCK
3-rod control with a cylinder (one-key system)

OPAL HANDLE
safety class 2



CORE
expanded polystyrene



GLAZING
triple-pane assembly in P4 class



DOOR LEAF THICKNESS 54 MM



4 INTERLOCKING DOOR BOLTS



EYEHOLE
in solid doors



ADJUSTABLE LOCK STRIKE



THREE 3-ELEMENT HINGES



THRESHOLD
made of stainless steel with perforation



DRIP TRAY
for door opening to the inside

* APPLICABLE FOR SOLID DOOR LEAVES

Door kit components

• **Door leaf** leaf the structure of which is based on double-layer wooden beams, which are amounted on the entire door leaf circumference. Expanded polystyrene with big graphite addition is used as a thermoinsulation core Door leaf casing is made of 0.6 mm galvanised steel sheet metal, finished with PVC film, resistant to weather conditions, or with polyester paint. • **Door frame** (Steel large angular 100 external)
 • **Three 3-element hinges** • **Two independent LOB locks** • **Four** interlocking door bolts • **OPAL handle** and upper escutcheon in safety class 2 • **Assembly set** • **Cylinders** • **Eyehole** (in solid door leaf at extra charge)
 • **An adjustable main lock** striker in a door frame • **Drip tray** in door leaf colour, for doors opened to the inside (at extra charge) • **Threshold** of stainless steel with perforation • In glazed models: **glazing** in 3-pane kit • **Frames** of stainless steel (inox pane frame)

Additional accessories / extra charges

- Size „100“
- Eyehole
- Drip cap in colour of door leaf
- Two LOB cylinders, class B - extra charge
- Lower 150 mm stainless steel, bilateral panel (A0, B1, F1 pattern)
- Core – mineral wool
- Lower protection after self-shortening
- Strengthening for self-closer
- 1500 mm round or rectangular handle

COLOURS

POLYESTER PAINT ★★★★★☆



PCV LAMINATED STEEL SHEET ★★★★★☆

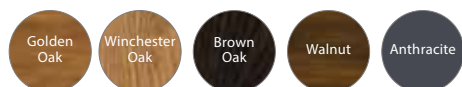

K Make a personal colour selection and enquire with Porta CONTRACT.

MODELS



model A0

model B1

model C1

model D1

model E1

model F1

Steel SAFE RC2 with Thermo

RC2* entrance door in anti-burglery version, provided with thermal door frame, intended for buildings. Available in a broad range of sheet metal covering with wood grain laminate or polyester paint coating.



Ud 1.2 W/m²K
HEAT TRANSFER COEFFICIENT*



THERMO STEEL DOOR FRAME

Large angular 100, external, with a thermal separator in door leaf colour, with a seal



UPPER LOCK

upper, 3-rod control with a cylinder (one-key system)



PRIMARY LOCK

3-rod control with cylinder (one-key system)
OPAL HANDLE
safety class 2



CORE

expanded polystyrene



GLAZING

triple-pane assembly in P4 class



DOOR LEAF THICKNESS 54 MM



4 INTERLOCKING DOOR BOLTS



EYEHOLE

in solid doors



ADJUSTABLE LOCK STRIKE



THREE 3-ELEMENT HINGES



THRESHOLD

thermal with an increased heat transfer coefficient, made of inox stainless steel sheet metal



DRIP CAP

for door opening to the inside

* APPLICABLE FOR SOLID DOOR LEAVES

Door kit components

• **Door leaf** the structure of which is based on double-layer wooden beams, which are amounted on the entire door leaf circumference. Expanded polystyrene with big graphite addition is used as a thermoinsulation core Door leaf casing is made of 0.6 mm galvanised steel sheet metal, finished with PVC film, resistant to weather conditions, or with polyester paint. • **Steel Thermo door frame** (large angular 100, external with thermal separator in door leaf colour with a seal) • **Three** 3-element hinges • **Two independent LOB** locks • **Four** interlocking door bolts • **OPAL handle** and upper escutcheon in safety class 2 • **Assembly set** • **Cylinders** • **Eyehole** (in solid door leaf at extra charge) • **An adjustable main lock** striker in a door frame • **Drip tray** in door leaf colour, for doors opened to the inside (at extra charge) • **Thermal threshold** with increased heat transfer coefficient, made of inox stainless steel sheet metal • In glazed models: **glazing** in 3-pane kit • **Frames** of stainless steel (inox pane frame)

Additional accessories / extra charges

- Size „100“
- Size
- Drip cap in colour of door leaf
- Two LOB cylinders, class B - extra charge
- Lower 150 mm stainless steel, bilateral panel (A0, B1, F1 pattern)
- Core – mineral wool
- Lower protection after self-shortening
- Strengthening for self-closer
- 1500 mm round or rectangular handle

COLOURS

POLYESTER PAINT ★★★★★☆



PCV LAMINATED STEEL SHEET ★★★★★☆



K Make a personal colour selection and enquire with Porta CONTRACT.

MODELS



model A.0

model B1

model C1

model D1

model E1

model F1

Steel SAFE RC3

RC3* entrance door, available in anti-burglary version, intended for buildings. Available in a broad range of sheet metal covering with wood grain laminate or polyester paint coating.



Ud 1.4 W/m²K
HEAT TRANSFER COEFFICIENT*



STEEL DOOR FRAME
Large angular 100, external, in door leaf colour, with a seal



HOOK - UPPER / LOWER LOCKING



STRIP LOCK
Winkhaus multipoint hook-bolt lock
SAFE HANDLE
safety class 3



CORE
expanded polystyrene



GLAZING
triple-pane assembly in P4 class



DOOR LEAF THICKNESS 54 MM



4 INTERLOCKING DOOR BOLTS



EYEHOLE
in solid doors



ADJUSTABLE LOCK STRIKE



THREE 3-ELEMENT HINGES



THRESHOLD
made of stainless steel with perforation



DRIP CAP
for door opening to the inside

* APPLICABLE FOR SOLID DOOR LEAVES

Door kit components

• **Door leaf** the structure of which is based on double-layer wooden beams, which are mounted on the entire door leaf circumference. The door leaf structure is additionally strengthened with a steel angle Expanded polystyrene with big graphite addition is used as a thermoinsulation core. Door leaf casing is made of 0.6 mm galvanised steel sheet metal, finished with PVC film, resistant to weather conditions, or with polyester paint. • **Door frame** (steel large angular 100 external) • **Three** 3-element hinges • **Winkhaus STV hook** lock with pressure mechanism • **Four** interlocking door bolts • **SAFE handle** in safety class 3 • Assembly set • **WILKA cylinder** • **Eyehole** (in solid door leaf - at extra charge) • **An adjustable main lock** striker in a door frame • **Drip cap** in door leaf colour, for doors opened to the inside (at extra charge) • **Thermal** threshold of increased heat transfer coefficient, made of inox stainless steel sheet metal • In glazed models: **combined** glazing with 0.5 coefficient and P4 anti-burglery class • **Stainless steel** frames (inox pane frame).

Additional accessories / extra charges

- Size „100“
- Eyehole
- Drip cap in door leaf colour
- Additional upper lock
- Stiff chain in painted doors
- Stiff chain in PVC-laminated doors
- Upper escutcheon in class C
- Lower WILKA lock cylinder, class B - replacement for basic kit in class A
- Upper WILKA lock cylinder, class A
- Upper WILKA lock cylinder, class B
- Lower 150 mm stainless steel, bilateral panel (A0, B1, F1 pattern)
- Core – mineral wool
- Lower protection after self-shortening
- Strengthening for self-closer
- 1500 mm round or rectangular handle

COLOURS

POLYESTER PAINT ★★★★★☆



PCV LAMINATED STEEL SHEET ★★★★★☆

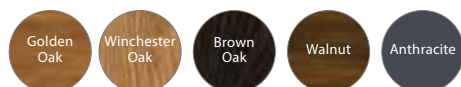

K  Make a personal colour selection and enquire with Porta CONTRACT.

MODELS



model A0

model B1

model C1

model D1

model E1

model F1

Steel SAFE RC3 with Thermo

RC3* entrance door in anti-burglery version, provided with thermal door frame, intended for buildings. Available in a broad range of sheet metal covering with wood-like laminate or polyester paint coating.

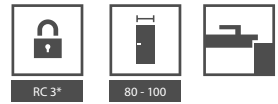

Ud 1.2 W/m²K
HEAT TRANSFER COEFFICIENT*



THERMO STEEL DOOR FRAME

Large angular 100, external, with a thermal separator in door leaf colour, with a seal



HOOK - UPPER / LOWER LOCKING



STRIP LOCK

Winkhaus multipoint hook-bolt lock

SAFE HANDLE

safety class 3



CORE

expanded polyster



GLAZING

triple-pane assembly in P4 class



THRESHOLD

thermal with an increased heat transfer coefficient, made of inox stainless steel sheet metal



DRIP CAP

for door opening to the inside



DOOR LEAF THICKNESS 54 MM



4 INTERLOCKING DOOR BOLTS



EYEHOLE

in solid doors



STIFF CHAIN



THREE 3-ELEMENT HINGES

* APPLICABLE FOR SOLID DOOR LEAVES

Door kit components

- **Door leaf** the structure of which is based on double-layer wooden beams, which are mounted on the entire door leaf circumference. The door leaf structure is additionally strengthened with a steel angle Expanded polystyrene with big graphite addition is used as a thermoinsulation core Door leaf casing is made of 0.6 mm galvanised steel sheet metal, finished with PVC film, resistant to weather conditions, or with polyester paint.
- **Thermo** steel door frame (large angular 100, external with thermal separator in door leaf colour with a seal)
- **Winkhaus STV hook lock** with pressure mechanism • **Four** interlocking door bolts • **SAFE handle** in safety class 3 • Assembly set • **WILKA** cylinder lock • **Eyehole** (in solid door leaf at extra charge) • **An adjustable main lock** striker in a door frame • **Drip cap** in door leaf colour, for doors opened to the inside (at extra charge) • **Thermal** threshold with increased heat transfer coefficient, made of inox stainless steel sheet metal • In glazed models: combined glazing with 0.5 coefficient and P4 anti-burglery class • **Stainless steel** frames (inox pane frame)

Additional accessories / extra charges

- Size "100"
- Eyehole
- Drip cap in door leaf colour
- Additional upper lock
- Stiff chain in painted doors
- Stiff chain in PVC-laminated doors
- Upper escutcheon in class C
- Lower WILKA lock cylinder, class B - replacement for basic kit in class A
- Upper WILKA lock cylinder, class A
- Upper WILKA lock cylinder, class B
- Lower 150 mm stainless steel, bilateral panel (A0, B1, F1 pattern)
- Core – mineral wool
- Lower protection after self-shortening
- Strengthening for self-closer
- 1500 mm round or rectangular handle

COLOURS

POLYESTER PAINT ★★★★★☆



PCV LAMINATED STEEL SHEET ★★★★★☆

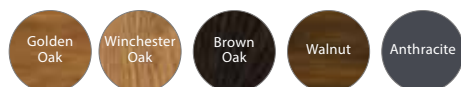

 Make a personal colour selection and enquire with Porta CONTRACT.

MODELS



model A0

model B1

model C1

model D1

model E1

model F1

Steel ENERGY PROTECT

RC3* entrance door with improved thermal features, available in anti-burglery version, intended for buildings. Available in a broad range of sheet metal covering with wood-like laminate or polyester paint coating.



RC 3*



80 - 100



Ud 1.1 W/m²K
HEAT TRANSFER COEFFICIENT*



THERMO STEEL DOOR FRAME

Large angular 100, external, with a thermal separator in door leaf colour, with a seal



HOOK - UPPER / LOWER LOCKING



STRIP LOCK

Winkhaus multipoint hook-bolt lock

SAFE HANDLE

safety class 3



SAFE ESCUTCHEON

for door knocker



DOOR LEAF THICKNESS 66 MM



4 INTERLOCKING DOOR BOLTS



EYEHOLE

in solid doors



STIFF CHAIN



THREE 3-ELEMENT HINGES



CORE

expanded polyester



GLAZING

triple-pane assembly in P4 class



THRESHOLD

thermal with an increased heat transfer coefficient, made of inox stainless steel sheet metal



DRIP CAP

for doors opening to the inside

* APPLICABLE FOR SOLID DOOR LEAVES

Door kit components

• **Door leaf** the structure of which is based on double-layer wooden beams, which are mounted on the entire door leaf circumference. The door leaf structure is additionally strengthened with a steel angle Expanded polystyrene with big graphite addition is used as a thermoinsulation core Door leaf casing is made of 0.6 mm galvanised steel sheet metal, finished with PVC film, resistant to weather conditions, or with polyester paint. • **Thermo** steel door frame (large angular 100, external with thermal separator in door leaf colour with a seal) • Door leaf tightness is ensured by a double seal system, the first and the second system, incorporated into door leaf and door frame, is uninterrupted and protects the door from four sides • **Three** 3-element hinges • **Winkhaus STV hook lock** with pressure mechanism • **Four** interlocking door bolts • **SAFE handle** in safety class 3 • Assembly set • **WILKA** cylinder lock • Eyehole (in solid door leaf at extra charge) • **Anadjustable main lock** striker in a door frame • **Drip cap** in door leaf colour, for doors opened to the inside (at extra charge) • **Thermal** threshold with increased heat transfer coefficient (made of inox stainless steel) • In glazed models: **combined** glazing with 0.5 coefficient and P4 anti-burglery class • **Stainless steel** frames (inox pane frame)

Additional accessories / extra charges

- Size "100"
- Eyehole
- Drip cap in door leaf colour
- Additional upper lock
- Stiff chain in painted doors
- Stiff chain in PVC-laminated doors
- Upper escutcheon in class C
- Lower WILKA lock cylinder, class B - replacement for basic kit in class A
- Upper WILKA lock cylinder, class A
- Upper WILKA lock cylinder, class B
- Lower 150 mm stainless steel, bilateral panel (A0, B1, F1 pattern)
- Core – mineral wool
- Lower protection after self-shortening
- Strengthening for self-closer
- 1500 mm round or rectangular handle

COLOURS

POLYESTER PAINT ★★★★★☆



PCV LAMINATED STEEL SHEET ★★★★★☆

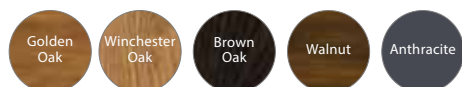

K  Make a personal colour selection and enquire with Porta CONTRACT.

MODELS



Steel ARCTIC PASSIVE

RC3* entrance door with the highest thermal features, available in anti-burglery version, intended for buildings. Available in a broad range of sheet metal covering with wood-like laminate or polyester paint coating.



Ud 0.95 W/m²K
HEAT TRANSFER COEFFICIENT*



WOODEN DOOR FRAME
with stainless steel cladding



HOOK - UPPER / LOWER LOCKING



STRIP LOCK
Winkhaus multipoint hook-bolt lock

SAFE HANDLE
safety class 3



CORE
expanded polyester



GLAZING
triple-pane assembly in P4 class



DOOR LEAF THICKNESS 56 MM



4 INTERLOCKING DOOR BOLTS



EYEHOLE
in solid doors



STRIKER STRIP



THREE 3D HINGES



WARM THRESHOLD
Porta ThermoControl



DRIP CAP
for doors opening™ to the inside

* APPLICABLE FOR SOLID DOOR LEAVES

Door kit components

- **Door leaf** with wooden frame-panel structure. Door frame made of multilayer glued coniferous timber, covered with 0.6 mm galvanised steel sheet metal; coated with PVC wood-like laminate, resistant to weather conditions, or painted with polyester paint. Internal core with frame structure, filled with expanded polystyrene with a big graphite addition
- **Wooden** door frame with 1.5 mm galvanised steel cladding, coated with PVC wood-like laminate or polyester paint
- Door leaf tightness is ensured by a double sealing system, the first and the second system is incorporated into door leaf and door frame and protects the door from four sides
- **Winkhaus STV hook lock** with pressure mechanism, in a kit with adjustable interlocking strip in the door frame
- **Strengthening** for self-closer
- **Four** interlocking door bolts
- **SAFE handle** in safety class 3
- **Three 3D hinges**
- **Four interlocking door bolts**
- **WILKA** lock cylinder
- **Eyehole** (in solid door leaf at extra charge)
- Drip cap in door leaf colour, for doors opened to the inside (at extra charge)
- **ThermoControl** threshold (wooden core with stainless steel cladding)
- In glazed **models**: combined glazing with 0.5 coefficient and P4 anti-burglery class
- **Stainless steel** frames (inox pane frame)

Additional accessories / extra charges

- Size "100"
- Eyehole
- Drip cap in door leaf colour
- Additional upper lock
- Stiff chain in painted doors
- Upper escutcheon in class C
- Lower WILKA lock cylinder, class B – replacement for basic kit in class A
- Upper WILKA lock cylinder, class A
- Upper WILKA lock cylinder, class B
- Lower 150 mm stainless steel, bilateral panel (A0, B1, F1 pattern)
- Core – mineral wool
- Strengthening for self-closer
- 1500 mm round or rectangular handle

COLOURS

POLYESTER PAINT ★★★★★☆



PCV LAMINATED STEEL SHEET ★★★★★☆

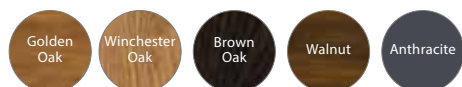

K  Make a personal colour selection and enquire with Porta CONTRACT.

MODELS

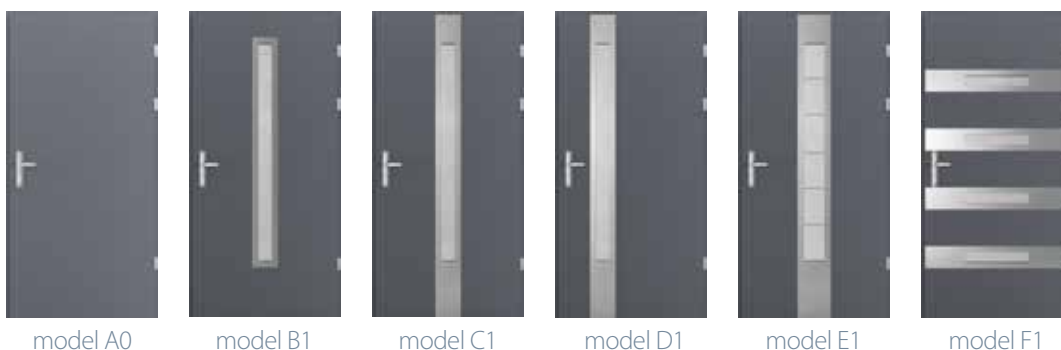

model A0

model B1

model C1

model D1

model E1

model F1

INTERNAL STEEL DOORS





POMESZCZENIE TECHNICZNE
TYLKO DLA PERSONELU

INTERNAL

BASIC INFORMATION ABOUT INTERNAL STEEL DOORS

PRODUCT OF
PORTA STEEL

DESIGN PATTERNS

- Solid
- Glazed
- Double

CORE TYPES

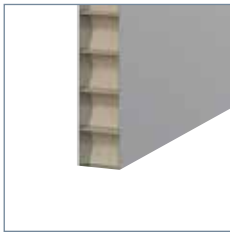

HONEYCOMB

This core reduces door weight, presents high mechanical resistance to pressure, offers an attractive price with universal applications.

Available in the following collections:
Metal BASIC, Metal SOLID

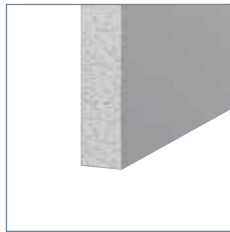

STYROFOAM

The core ensures structural stability, thermal insulation, resistance to moisture, improved mechanical parameters.

Available in the following collections:
Metal BASIC, Metal SOLID

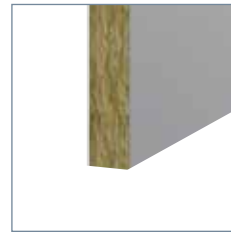

MINERAL WOOL

This core ensures thermal and acoustic insulation, non flammability, structural stability and improved mechanical parameters.

Available in the following collections:
Metal SOLID, EI30, EI60

SEALS

Made of high quality plastic of very good mechanical properties and good shape memory, what guarantees optimal utility parameters.

TRANSOMS

For use with Metal BASIC and Metal SOLID door leaves. There are upper, lateral, upper and lateral transoms

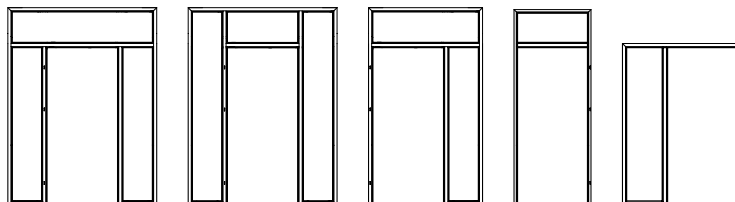



ACCESSORIES

of main European manufacturers (see pp. 48-49)

- Locks
- Anti-panic locks
- Hinges
- Surface self-closers (rail, arm)
- Integrated strikes, stainless steel sheet metal strikes
- Electric strikes
- Electric jumpers
- Thresholds
- Panels





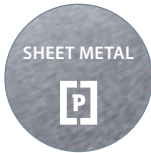

FINISH TYPES

for more information (see p. 10)

- Galvanised sheet metal
- Coated sheet metal
- Polyester paint
- PVC-laminated steel sheet metal
- Stainless steel



PARAMETERS

	MECHANICAL CLASS			FIRE RESISTANCE			ACOUSTIC INSULATION
	 klasa 1	 klasa 2	 class 3	 EI 30	 EI 60	 So, Sm	 Rw 37dB D, 35
UNIVERSAL DOORS TO UTILITY PREMISES	●	○	○	○	○	○	○
Metal BASIC door	○	●	○	○	○	○	○
Metal SOLID door	○	○	●	○	○	○	○
EI 30 door	○	●	○	●	○	○	○
EI 60 door STANDARD type	○	○	●	○	●	○	○
EI 60 door Type 1	○	○	●	○	●	●	●

MECHANICAL CLASS Door mechanical resistance to vertical loads, static torsion and impacts; corresponding to normal use, depending on performance conditions (light-, medium-, heavy- and very heavy duty).

FIRE RESISTANCE The ability to stop flame spreading for a definite time period, 30 and 60 minutes for EI30 and EI60 class, respectively.

SMOKE-PROOFNESS Defines door resistance (tightness) to smoke permeability in room and increased (to 200 oC) temperature.

ACOUSTIC INSULATION Defined by Rw and D coefficient of acoustic insulation, indicates the decibel level of outdoor noise which the door will be able to attenuate.

INTERNAL

UNIVERSAL DOORS TO UTILITY PREMISES

AT-15-8081/2016, ITB WARSAW

Heavy-duty, galvanised, multi-purpose door. Symmetrical design and universal fittings (lock, hinges) make it possible to install the door in left- and right-hand applications.



LEFT – OR RIGHT – HAND VERSION? UNIVERSAL



Industrial Pattern
W.121254



PRODUCT OF
PORTA STEEL



MODELS

SOLID



front of the
door leaf



back of the
door leaf

MODEL 2 (VENTILATED)



front of the
door leaf



back of the
door leaf

Door kit components

- Door leaf (painted sheet metal, zinc-coated) • Door frame (painted sheet metal, zinc-coated)
- Two standard pintle hinges • Patented cylinder lock • Handles with escutcheons

Additional options

- Ventilation grille

Door frame included in the price

- Angle-bar metal door frame, 48 mm profile
Made of 0.8 mm sheet metal, zinc-coated on both sides

Non-standard dimensions



Height with varnished door frame	$H_s = \text{max. } 2430 \text{ mm, min. } 1300 \text{ mm}$
Height with zinc-coated door frame	$H_s = \text{max. } 2080 \text{ mm, min. } 2030 \text{ mm}$
Width	$S_s = \text{max. } 1015 \text{ mm, min. } 315 \text{ mm}$

COLOURS

POLYESTER PAINT ★★★★★☆



ZINC-COATED SHEET METAL ★★★★★☆



 Porta KONTRAKT allows you to adapt the door to your individual needs.



4 ASSETS IN 1
SEE MORE



www.porta.com.pl/dm/universalne_montaz.wmv

Metal BASIC

AT-15-8081/2016, ITB WARSAW, HYGIENIC CERTIFICATE 55/322/58/2014



An economical solution with top performance parameters maintained.
Zinc-coated steel design guarantees high levels of durability and reliability.



PRODUCT OF
PORTA STEEL



METAL FRAME REBATE



LOCK AND HANDLE



SPOT-WELDED DOOR FRAME
(44 MM PROFILE, AS THE SMALL
ANGLE-BAR VERSION)



PINTLE HINGES

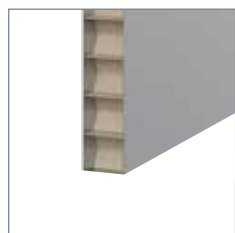

CORE OPTIONS
HONEYCOMB

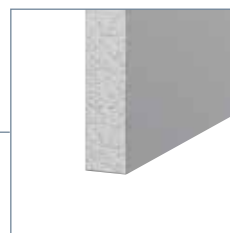

CORE OPTIONS
POLYSTYRENE

Door set components

- **Door leaf** (0.5 mm painted sheet metal with a polyester film, zinc-coated)
- **Door frame** (painted, zinc-coated steel) • **Two** standard pintle **hinges**
- Patented cylinder **lock** • Handles with escutcheons

Door leaf elements

- **Door leaf** (0.5 mm painted sheet metal with a polyester film, zinc-coated)
- **Two** standard pintle **hinges** • Patented cylinder **lock** • Handles with escutcheons

Accessories



- Ventilation grille • Sleeves

Door frame included in the price

- Metal angle-bar door frame, 44 mm profile (as the Small Angle-bar). Made of 1.2 mm sheet metal, zinccoated on both sides. Equipped with a closing seal.
- Door frame available in the left- and right-hand version, for placement on a finished floor surface.

Non-standard dimensions



Height with painted door frame	$H_s = \text{max. } 2080 \text{ mm, min. } 1300 \text{ mm}$
Height with zinc-coated door frame	$H_s = \text{max. } 2080 \text{ mm, min. } 2030 \text{ mm}$
Width	$S_s = \text{max. } 1162 \text{ mm, min. } 352 \text{ mm}$

Notes

- Metal BASIC door is made acc. to the investment standard (see the table of dimensions, p. 50).
- Metal BASIC door leaf can be made acc. to the investment standard and the Polish standard

COLOURS

COATED SHEET ★★★★★☆



ZINC-COATED STEEL ★★★★★☆



Porta KONTRAKT allows you to adapt the door to your individual needs.

Metal SOLID

AT-15-8081/2016, ITB WARSAW, HYGIENIC CERTIFICATE 55/322/58/2014

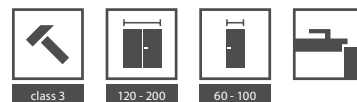

A broad range of applications at residential buildings and flats, intended for use also in heavy-duty conditions. High-quality paint finish available in any colour makes the product perfectly suited for specific needs of individual customers.

METAL DOOR FRAME REBATE

LOCK AND HANDLE

ZINC-COATED STEEL

ACID-PROOF STEEL

PRODUCT OF PORTA STEEL

CORE OPTIONS HONEYCOMB

CORE OPTIONS POLYSTYRENE

CORE OPTIONS MINERAL WOOL

MODELS



Door leaf elements

- Door leaf (0,6 mm powder-coated sheet metal, zinc-coated)
- Two or three pintle hinges standard • Patented cylinder lock
- Transparent or mat tempered glass (models 1-5)

Accessories



- Ventilation grille • Sleeves • Handle with escutcheon (EDEL)

Door frames

- Angle-bar SMALL, Angle-bar LARGE, Angle-bar LARGE FOLDING door frame.
- ADJUSTABLE (standard), ADJUSTABLE PS „with sharp edges“ door frame

Non-standard dimensions



Height with painted door frame	H _s = max. 2430 mm, min. 530 mm
Height with laminated door frame	H _s = max. 2040 mm, min. 530 mm
Height with assembled stainless steel door frame	H _s = max. 2080 mm, min. 530 mm
Door leaf width (polyester paint)	S _s = max. 1244 mm, min. 344 mm
Door leaf width (PVC coated sheet metal)	S _s = maks. 1044 mm, min. 344 mm
Door leaf width (stainless steel)	S _s = maks. 1162 mm, min. 344 mm

Supplementary costs

- Size „100“ (zinc-coated door leaves)
- Size „100“ (acid-proof steel door leaves)
- PVC-laminated door leaves (Golden Oak, Mahogany, Walnut)
- PVC-laminated door leaves (Anthracite)
- Ventilation sleeves or grille (zinc-coated leaves)
- Patented lock handle with escutcheon (EDEL)
- WC handle with escutcheon (EDEL)

COLOURS

ZINC-COATED STEEL ★★★★★☆



POLYESTER PAINT ★★★★★☆



PVC-LAMINATED STEEL SHEET ★★★★★☆



ACID-PROOF STEEL ★★★★★★



Porta KONTRAKT allows you to adapt the door to your individual needs.

Metal EI 30, EI 60

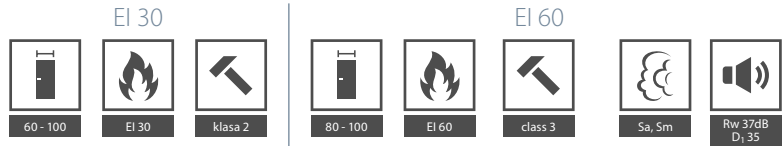

TYPE 1 only

AT-15-7236/2016, ITB WARSAW, HYGIENIC CERTIFICATE 55/322/58/2014

Fire resistant door, available in two protection versions – fire resistance for 30 or 60 minutes, outdoor and indoor applications, in EI₂60 version with threshold, smoke proof and with Rw 37 dB acoustic insulation (type 1). Uncompromised protection where necessary!



MODELS



EI 30 solid EI 30 model 1 EI 30 model 2 EI 30 model 3 EI 60 pelne EI 60 model 1 EI 60 model 2 EI 60 model 3

Door leaf elements

• **Door leaf** (0.8 mm galvanised sheet metal with painted coating) • **Door frame** (1.5 mm galvanised sheet metal with painted coating) • **Two steel bolted hinges**, including one spring-loaded • **Lock** for lock cylinder • **Set of handles with escutcheons** (separately ordered) • **TYPE 1 EI 60 metal door - smoke proof and Rw 37dB in a kit with threshold** in door frame, optional preparation for surface self-closer and eyehole

Accessories



• **Additional upper lock** for lock cylinder • **Anti-panic bars** possible in handle - handle and handle - anti-panic bar configurations
• **Additionally for EI 60:** • **ventilation grille** (door without smoke proofness parameter) • **Electric strikes:**
- **standard version** on the primary lock - **reversing action** on additional upper latch lock

Door frame included in the price

• **Metal angular door frame with profile width of 84 mm (EI30) and 110 mm (EI60)**, made of 1.5 mm steel sheet metal, hot galvanised on both sides. Provided with a closing seal and a swelling seal
• **Possible order of metal door frame in two versions:**
- **directional door frame** (in left- and right-hand version) for placement on finished floor surface
- **level "0"**, a threshold for extra charge (EI 30 and EI 60)
- **universal door frame** - to be mounted in floor screed - level of "-30"
TYPE 1 - EI 60 metal, smoke proof and Rw 37 dB door - with threshold

Non-standard dimensions



Metal EI 30	$H_s = \text{max. } 2090 \text{ mm, min. } 1572 \text{ mm}$
Metal EI 60	$H_s = \text{max. } 2200 \text{ mm, min. } 1650 \text{ mm}$
Metal EI 30	$S_s = \text{max. } 1080 \text{ mm, min. } 570 \text{ mm}$
Metal EI 60	$S_s = \text{max. } 1116 \text{ mm, min. } 558 \text{ mm}$

Supplementary costs

• Size „100“ for metal door leaves (EI 60)
• Fire resistant eyehole
• Metal threshold (only for EI 30)
• Strengthening for additional self-closer

Notes

• For entrance doors: in glazed designs, it is necessary to apply window pane with special parameters - the price and lead time to be agreed with the Contract Department of the PORTA Company. A possibility to use an extended profile - up to 390 mm - the price and lead time to be agreed with the Contract Department of the PORTA Company.

COLOURS

POLYESTER PAINT ★★★★★☆



Porta KONTRAKT allows you to adapt the door to your individual needs.

EI 60 doors are available as two types:

Standard type:
60-minute fire resistance,
mechanical class 3

Type 1:
features of Standard type
doors, smoke resistance S_a, S_m

TRANSOMS



Transoms, made in the same profile system, perfectly complement the offer of metal door frames. The transoms enable - in a simple and functional way - to provide additional illumination to a room, separated by a wall, or to isolate rooms, while maintaining visual communication among them. Such solutions are found at office premises, hospitals and schools. The state-of-the-art machinery of the Porta Company enables production of metal transoms in various configurations, both as separate structures and combined with door frames. Combined transoms are available in one of the upper, lateral left and right transom variants or may be installed in all these variants together, i.e., as one assembly. Regarding the products, presented in this publication, the transom-door frame combinations are available for steel door leaves of Metal BASIC and Metal SOLID collections.

EXAMPLES OF OPTIONS

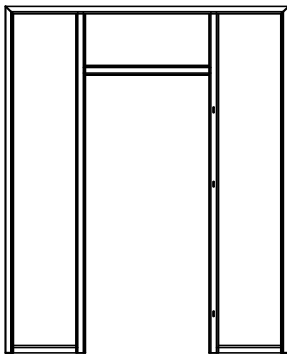

Upper and bilateral transom,
version 1

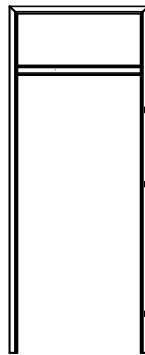

Upper transom

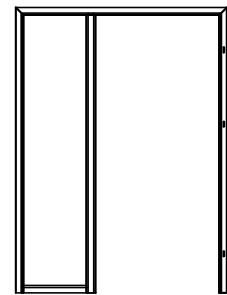

Lateral transom
(right / left)

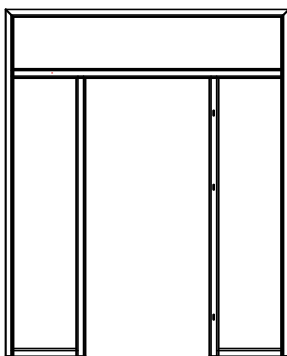

Upper and bilateral transom,
version 2

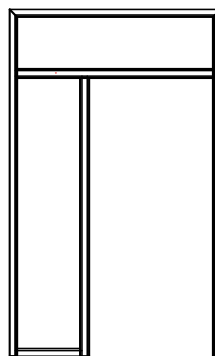

Upper and lateral transom,
one-sided (right / left)

Transom dimensional scopes (overall dimensions)

	Min. width [mm]	Max. width [mm]	Min. height [mm]	Max. height. [mm]
Door frames for single-leaf doors	950	2200	2070	3500
Door frames for double-leaf doors	950	2200	2070	3500

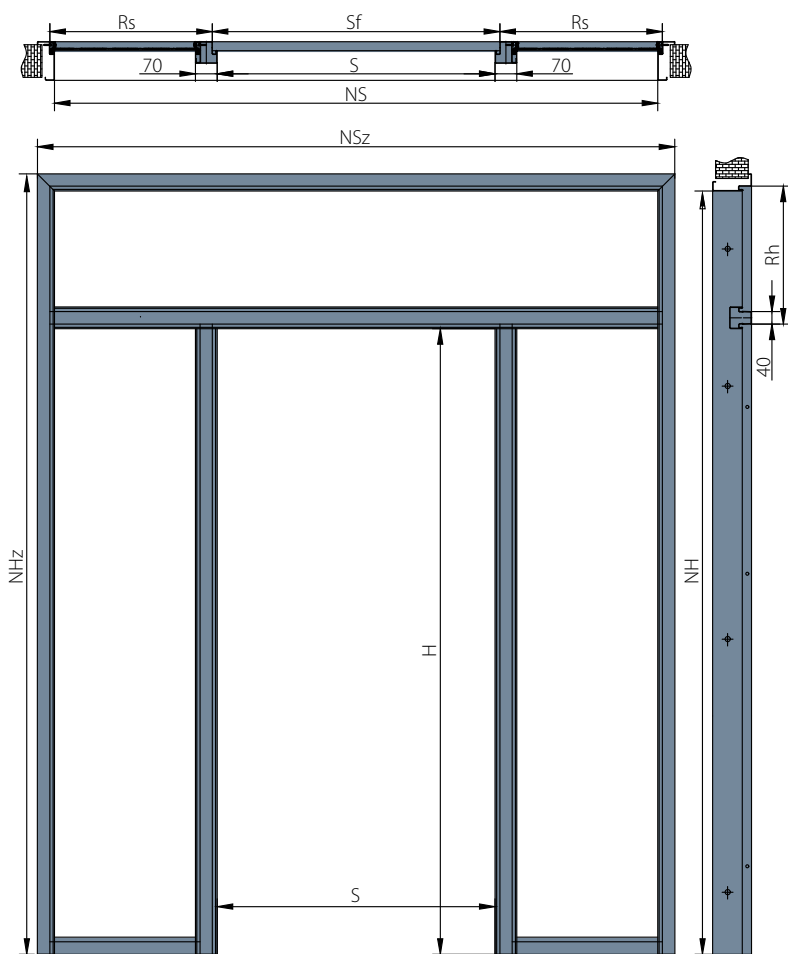

LEGEND

- H - height in door frame lumen
- NH - height in transom lumen
- NH_z - external transom height
- R_h - rheight extension (transom bar + glazing)
- S - width in door frame lumen
- S_f - width in door frame welt
- N_S - with in lumen, together with lateral transom
- N_{Sz} - external transom width
- R_s - width extension (transom bar + glazing)



THRESHOLDS



Stainless steel thresholds perfectly complement the offer of Porta doors. A rich offer of profiles is tailored to structures of door leaves and door frames, both wooden and metal. Simultaneously, the threshold itself is distinguished by high aesthetics, being an interesting element of interior design. The threshold enables to separate rooms in a simple and functional way, while ensuring better acoustic insulation vs. solutions without threshold. The state-of-the-art machinery of the Porta Company enables production of thresholds in various configurations, both for single- and double-leaf doors. Profile shapes are adapted to door leaves in rebated and non rebated versions. The threshold provides a natural completion of door frame and increases the functionality of the entire door assembly.

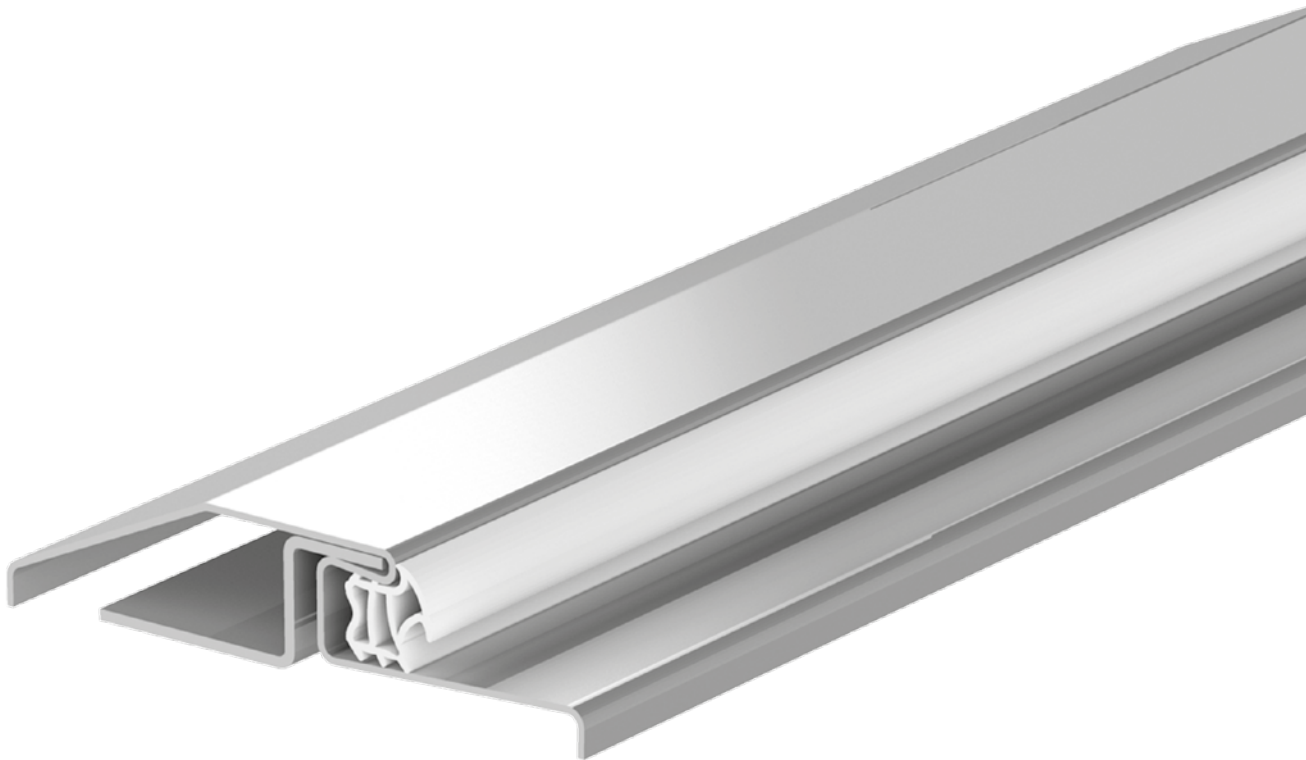

Threshold applications in PORTA doors

Threshold version	Profile [mm]	Application	Proposed application
Indoor	90	entrance doors AGAT, OPAL, KWARC	metal doors, wooden and industrial doors
Indoor	120	entrance doors AGAT, OPAL, KWARC	metal doors, wooden and industrial doors
GRANIT	120	entrance doors GRANIT	
Metal EI 30	83,5	EI 30 metal door	it is possible to match any door type
Metal EI 60	105	EI 60 metal door	it is possible to match any door type

 **ATTENTION!** Solution details to be agreed with the Contract Department of the Porta Company – structural changes may be necessary in selected threshold profile.

THRESHOLD TYPES

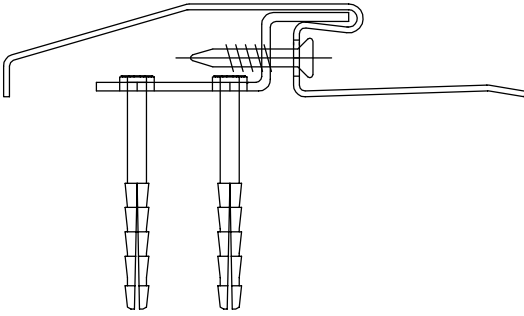

90 mm,
internal doors

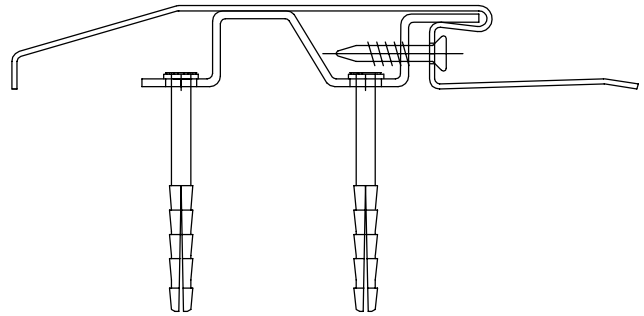

120 mm,
internal doors

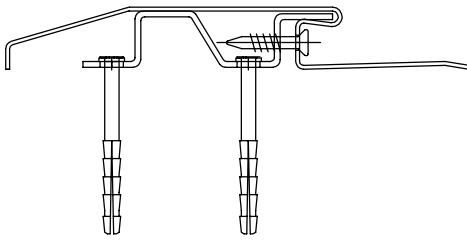

120 mm,
GRANIT

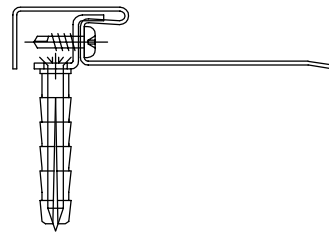

83,5 mm,
Metal EI 30

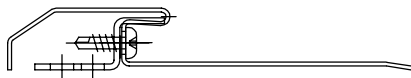

105 mm,
Metal EI 60

ATTENTION! Every threshold has got a seal, masking the assembly of its components.

PANELS



Stainless steel panels, mounted on door leaf surfaces, perfectly complement the offer of Porta doors. Depending on version, the panels may be used as door leaf protection in its lower part, which is most often exposed to contact(s) with users, as well as in the upper region of the lock. A rich offer of panels includes versions which provide air exchange through holes in ventilation grilles, sleeves or integrated ventilation panels. The state-of-the-art machinery of the Porta Company enables broad matching of panel sizes and their integration with any accessories which can be mounted on the door. It is very important, taking into account the broad scope of door applications, including investments at office buildings, hospitals, schools and hotels, as well as in other objects where the customer needs additional door surface protection for the character of given environment.

PROTECTION PANELS



Kick-panel



Ventilation panel



Push-panel



Panel applications in PORTA doors

Sheet metal type	Thickness [mm]	Application	Proposed application K
1.4301 (V2A) acc. to EN 10088	0,6	ENDURO door	metal doors, wooden and industrial doors
1.4404 (V4A) acc. to EN 10088	0,8	AQUA door	metal doors, wooden and industrial doors

PROTECTION PANEL TYPES



Kick-panel

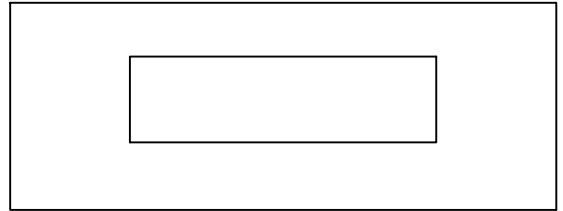

Kick-panel (ventilation grille)

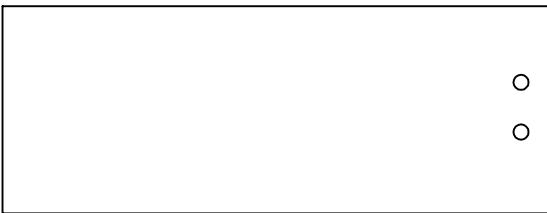

Push-panel (WC lock)

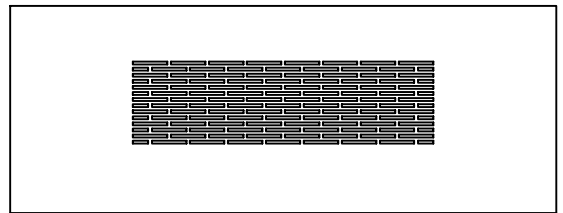

Ventilation panel



Push-panel (patented lock)

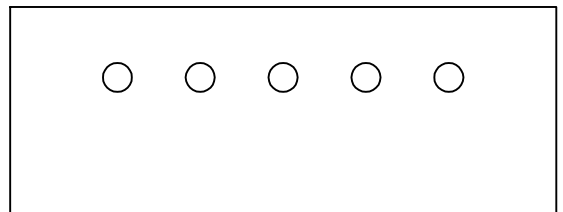

Kick-panel with holes for sleeves
(1 row)

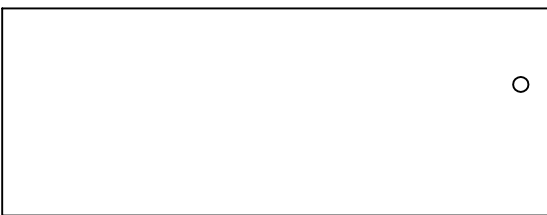

Push-panel (handle only)

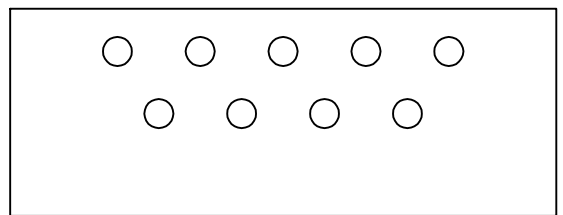

Kick-panel with holes for sleeves
(2 rows)



Push-panel (key only)



Kick-panel for door leaf in pendulum version

INTERNAL

ACCESORIES FOR INTERNAL DOORS

HINGE EXAMPLES



Seat for type V hinges



ELECTRIC STRIKE FOR SINGLE-LEAF DOORS



Electric strike to support the primary lock

SELF-CLOSERS



Surface arm self-closer



Surface rail self-closer

STAINLESS STEEL PORTHOLE



Stainless steel porthole
Internal diameter of 250 mm for „60“ i „70“ door leaves
and 300 mm for other versions

ELECTROMAGNETIC HOLDER



Wall element



Assembly in unlocked condition



Assembly in locked condition



VENTILATION AND PROTECTION PANELS



Fire resistant grille, powder coated
(manufacturer: Lorient)



Stainless steel grille
(manufacturer: Porta)

ELECTRIC JUMPER



Electric jumper

SEMI-AUTOMATIC FLUSH BOLT



Unlocked assembly



Locked assembly

LOCKS



Primary lock



Roller lock



Upper lock for lock cylinder



Economy lock

ANTI-PANIC LOCKS



Single leaf assembly
(version with handle)



Double-leaf assembly
(version with lever)

Anti-panic function B - the interior handle with classical panic function opens the lock regardless of its closure state; the exterior handle is connected (unbolted lock) or disconnected (bolted lock) mechanically depending on the needs. The coupling of two handles is provided by a divided spindle. The coupling of both handles is ensured by divided spindle. Application: in emergency exit doors of public utility buildings.

INTERNAL

EXPLANATION OF SYMBOLS

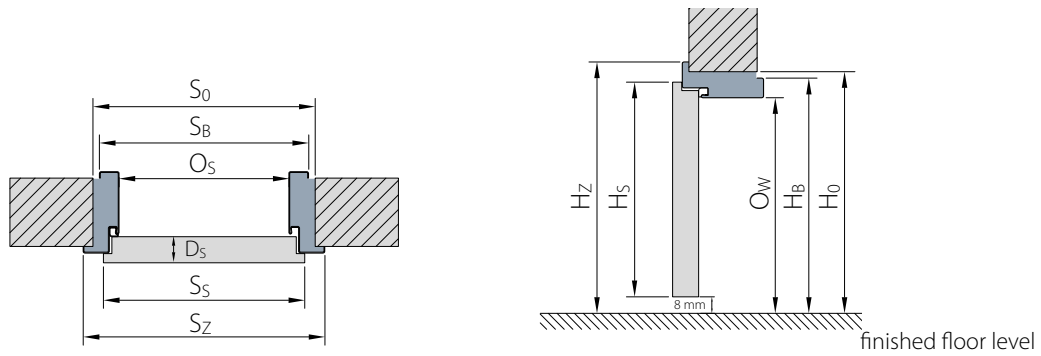

LEGEND OF DIMENSIONS

- S_s total leaf width, including rebates
- H_s total leaf height, including rebate
- D_s thickness of door leaf
- S_0 width of wall opening ready for door frame setting
- H_0 height of wall opening ready for door frame setting, measured from the finished floor level
- O_s clear width of the door frame
- O_w clear height of the door frame (for the doors with athreshold the height of threshold is deducted for this dimension)
- S_B width of door frame, door trims exclude
- H_B height of door frame, door trims excluded
- S_z total width of door frame, including door trims
- H_z total height of door frame, including door trims
- $T_{s/w}$ permissible deviation from width/height of wall opening

TABLES WITH DIMENSIONS

INDUSTRIAL DOORS

DOORS	SIZE	S_s	H_s	D_s	S_0	H_0	O_s	O_w	S_B	H_B	$S_z(6)$	$S_z(8)$	H_z	$T_{s/w}$
Metal EI 30	60	700	2040	53	695	2065	640	2037**	673	2053	730	-	2080	±10 / ±5
	70	800			795		740		773		830	-		
	80	900			895		840		873		930	-		
	90	1000			995		940		973		1030	-		
	100	1080			1075		1020		1053		1110	-		
Metal EI 60	80	916	2060	67	930	2075	841	2029**	911	2074	977	-	2097	±10/±5
	90	1016			1030		941		1011		1077	-		
	100	1116			1130		1041		1111		1177	-		
Universal doors for utility rooms	70	715	2017	40 *	760	2050	700	2018	739	2038	796	-	2066	±10 / ±5
	80	815			860		800		839		896	-		
	90	915			960		900		939		996	-		
Metal BASIC with SMALL angle-bar door frame	80	852	2030	40	860	2045	804	2016	837	2033	894	-	2061	±10/±5
	90	952			960		904		937		994	-		
	100	1052			1060		1004		1037		1094	-		

* Door leaf thickness, measured on vertical edges (door leaf without core, opened from the closing side).

** The application of metal threshold will reduce the specified dimension by 16 mm.

ENTRANCE DOOR

DOORS	SIZE	S_s	H_s	D_s	S_0	H_0	O_s	O_w	S_B	H_B	S_z	H_z	$T_{s/w}$
Steel SAFE RC2 Steel SAFE RC3	80	868	2037	54	900	2065	820	2023*	880	2053	930	2078	±10/±5
	90	968			1000		920		980		1030		
	100	1068			1100		1020		1080		1130		
Steel SAFE RC2 THERMO Steel SAFE RC3 THERMO	80	868	2037	54	900	2065	822	2023*	882	2053	932	2078	±10/±5
	90	968			1000		922		982		1032		
	100	1068			1100		1022		1082		1132		
Steel ENERGY PROTECT	80	868	2037	66	900	2065	822	2023*	882	2053	932	2078	±10/±5
	90	968			1000		922		982		1032		
	100	1068			1100		1022		1082		1132		
Steel ARCTIC PASSIVE	80	868	2049	56	940	2099	820	2002	820	2089	924	2091	±10/±5
	90	968			1040		920		1020		1024		
	100	1068			1140		1020		1120		1124		

* The application of metal threshold will reduce the specified O_w dimension by 16 mm.

METAL DOOR FRAMES

DOOR FRAME TYPE	SIZE	S _s	H _s	D _s	S ₀	H ₀	O _s	O _w **	S _B	H _B	S _Z	H _Z	T _{sw}
with SMALL ANGULAR door frame	60	644	2030	40	650	2045	596	2016	629	2033	686	2061	±10/±5
	70	744			750		696		729		786		
	80*	844			850		796		829		886		
	90*	944			950		896		929		986		
	100	1044			1050		996		1029		1086		
with door frames: LARGE ANGULAR for brick walls AND LARGE ANGULAR ASSEMBLED of stainless steel	60	644	2030	40	675	2055	596	2016	656	2046	686	2061	±10/±5
	70	744			775		696		756		786		
	80*	844			875		796		856		886		
	90*	944			975		896		956		986		
	100	1044			1075		996		1056		1086		
	110	1144			1175		1096		1156		1186		
with LARGE ANGULAR ASSEMBLED door frame in PVC finish	60	644	2030	40	675	2055	596	2016	656	2046	706	2071	±10/±5
	70	744			775		696		756		806		
	80*	844			875		796		856		906		
	90*	944			975		896		956		1006		
	100	1044			1075		996		1056		1106		
	110	1144			1175		1096		1156		1206		
with LARGE ANGULAR door frame for plasterboard walls	60	644	2030	40	680	2055	596	2016	656	2046	686	2061	+10/+5
	70	744			780		696		756		786		
	80*	844			880		796		856		886		
	90*	944			980		896		956		986		
	100	1044			1080		996		1056		1086		
	110	1144			1180		1096		1156		1186		
with ADJUSTABLE door frame	60	644	2030	40	700	2070	596	2016	680	2058	716	2076	-10/-5
	70	744			800		696		780		816		
	80*	844			900		796		880		916		
	90*	944			1000		896		980		1016		
	100	1044			1100		996		1080		1116		
	110	1144			1200		1096		1180		1216		
with ADJUSTABLE door frame (PS "for edge")	60	644	2030	40	700	2070	596	2016	679	2058	736	2086	-10/-5
	70	744			800		696		779		836		
	80*	844			900		796		879		936		
	90*	944			1000		896		979		1036		
	100	1044			1100		996		1079		1136		

- * Orders acc. to the investment standard (passage lumen of 800, 900 mm) – available as standard – without extra charge (investment standard 8 mm should be added to S₀). Please, remember also to properly select the size of door leaves, dedicated to the assembly.
- ** The application of metal threshold will reduce the specified dimension by 16 mm.

COMMENTS:

- Dimension tolerance acc. to PN: up to 1 m: ± 1 mm, above 1 m: ± 2 mm.
- In order to obtain S₀ dimension for double leaf door, it is necessary:
 - a) for rebated door leaves: up to S₀ dimension, provided in Table 1 for single door leaf (rebated), add S_s dimension of the second door leaf (rebated) or of a (rebated) side panel – it applies to the assembly with the Porta SYSTEM door frame for rebated door leaves: to S₀ dimension, specified in Table 1 for single door leaf (rebated), add S_s dimension of the second door leaf (rebated) or of a side panel (rebated) and reduce the obtained value additionally by 10 mm – it applies to options with the other door frames.
 - b) for non rebated door leaves: to S₀ dimension, specified in Table 1 for single door leaf (non rebated), add S_s dimension of the second door leaf (non rebated) or of side panel (non rebated), increased by 16 mm.
- Side panels for rebated doors, available in natural finish, are offered in "40" size, where S_s=444, H_s=2030.
- The door frames are designed to be mounted on finished floor. In case of metal door frames, it is possible to order their longer version (by 30 mm) to be mounted in the floor screed. Then, the specified H_B and H_Z dimensions should be increased by 30 mm ("30" level).
- The door leaf dimension, specified in the table for internal door leaves, applies to both rebated and sliding leaf versions.
- Porta SYSTEM integrated with upper transom, dimensions: H₀, H_B and H_Z +302 mm.
- Using the PROJEKT door frame, enlarge the hole in brick wall S₀ by 25 mm and the height H₀ by 15 mm (the tolerance or results ±10 mm / ±5 mm).

PORTA'S COMPREHENSIVE OFFER

A wide selection of Porta doors allows you to choose the right product according to both the customer's taste and needs. We continuously follow the trends in design, to make our offer valid and attractive. We make sure that the product colours meet the customer's tastes. At the same time we pay attention to detail, which is why Porta is a brand that combines functional solutions with high quality.



INTERIOR DOORS in synthetic veneers

We offer a wide range of door designs and veneers for houses, apartments, lofts and offices. Both lovers of classic designs as well as people interested in the latest trends will find a product meeting their needs in our offer.



INTERIOR DOORS in natural veneers

For the lovers of good taste, impressive and elegant solutions, we have prepared a collection of doors in natural veneers. Here you can find both traditional and modern doors.



INTERIOR ENTRANCE DOORS

Porta interior entrance doors are available as reinforced doors, fireproof doors and burglarproof doors. It is worth mentioning that the entrance doors have the same colour scheme as the doors to the rooms. Therefore, it is easy to match the colour of the entrance door to the doors inside the apartment.



EXTERIOR ENTRANCE DOORS

Exterior doors complement the style of the building, as well as provide protection against noise, cold and moisture. Porta doors have exceptional thermal insulation properties, which combined with the use of effective anti-theft solutions ensure a sense of security and comfort.



TECHNICAL DOORS

Technical doors are an indispensable complement to the series of doors used in public buildings, shopping malls, cinemas, etc. Such doors can also be found in use in residential houses. A wide range of Porta technical doors allows to meet all the requirements of the building in the area of fire protection and sound insulation.



STEEL DOORS

The use of high-quality galvanised and acid-proof steel allows us to offer doors resistant to weather conditions and aggressive environments in laboratories, swimming pools, etc.

Steel doors are perfect for technical areas of commercial buildings, garages, basements and areas with increased hygienic requirements.



DOOR FRAMES, TRANSOMS

A wide range of Porta door frames, both steel and wooden, makes it possible to match the parameters and properties that meet all the expectations of the designer or user. The same type and colour of the veneer as the door leaf allows us to offer a complete door set with uniform visual and functional parameters.



PANELS, BUILT-IN FURNITURE

Continuously growing interest in door portals and all kinds of built-in furniture was reflected in Porta's product offer. We offer wall panels made of panels with a properly chosen thickness and any size, veneered with the same veneer as the door.

This allows us to create complex, visually uniform built-in furniture in the immediate surroundings of the door.

ADAPT INTERNAL DOORS TO FIT YOUR NEEDS

① DOOR FRAME FITTING TO EXISTING DOOR LEAF

OR

② DOOR LEAF FITTING

OR

③ DOOR FITTING TO THE HOLE IN BRICK WALL (Specify Ho, So)

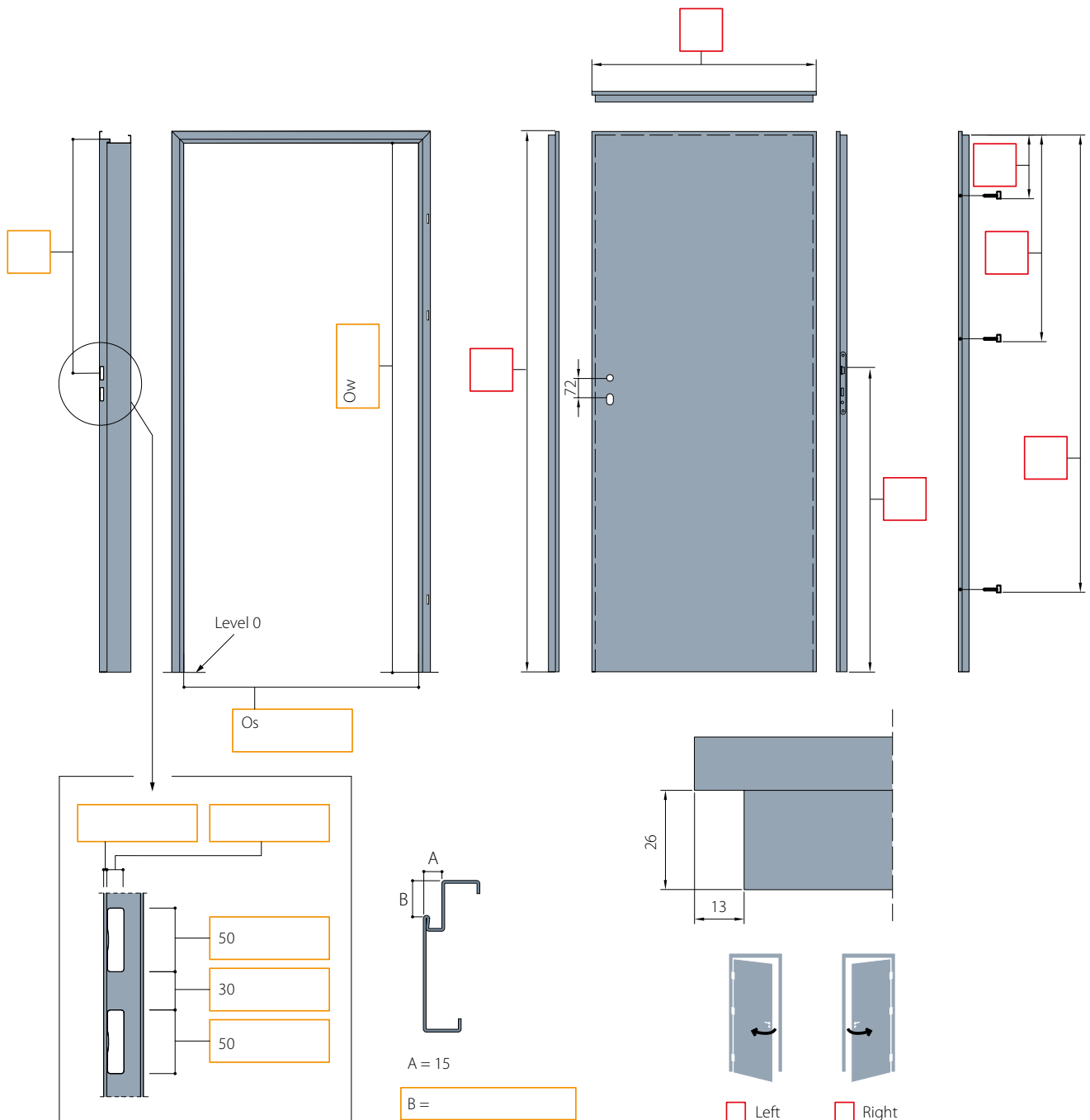

Additional Information:

Ow - height in door frame lumen (measured from the level of finished floor)

Os - width in door frame lumen

Ho - height of brick wall opening ready for door frame setting (measured from the level of finished floor)

So - width of brick wall opening ready for door frame setting

K The processing of orders beyond standard offer is carried out by the dedicated Contract Department



A set consisting of the stainless steel door frame and the stainless steel door leaf used in a medical laboratory.

PORTA distribution network:

- AUSTRALIA
- AUSTRIA
- BELARUS
- BULGARIA
- CROATIA
- CZECH REPUBLIC
- ESTONIA
- FRANCE
- GERMANY
- GREAT BRITAIN
- GREECE
- HUNGARY
- ISRAEL
- ITALY
- LATVIA
- LIECHTENSTEIN
- LITHUANIA
- MACEDONIA
- MALTA
- NIGERIA
- NORWAY
- OMAN
- ROMANIA
- RUSSIA
- SERBIA
- SLOVAK REPUBLIC
- SLOVENIA
- SPAIN
- SWEDEN
- SWITZERLAND
- TAJIKISTAN
- TURKEY
- UKRAINE



- PORTA's factories
- PORTA dealers network

Stamp: